



HIGHNESSTM

HM104SV111AM-UR
10.4" Color TFT-LCD

FUNCTIONAL DRAFT SPECIFICATION

(This document is meant for customers' approval)

Release Date
16th Jul 2020

THIS DOCUMENT CONTAINS PROPRIETARY INFORMATION WHICH IS SOLELY OWENED BY 'HIGHNESS MICROELECTRONICS PVT. LTD.' ANY UNAUTHORISED COPY OR PRINTING OR PUBLISHING OF INFORMATION IN THIS DOCUMENT IN PART OR IN COMPLETE IS RESTRICTED.

HIGHNESS MICROELECTRONICS PVT. LTD

URL: www.highnessmicro.com, Email: sales@highnessmicro.com

1. INSTRUCTION

10.4" Display Module is a color active matrix TFT-LCD that uses amorphous silicon TFT as a switching device. This model is composed of a TFT-LCD panel, a driving circuit with LVDS interface. This TFT-LCD has a high resolution (800(R.G.B) X 600) and can display up to 262,144 colors.

1.1 Features

The TFT LCD module is a complete HMI module. It is able to handle the TFT panel by [UART](#) (Universal Asynchronous Receiver/Transmitter), [RS-232](#) and [USB](#) interface. The user can easy use/control the TFT Panel by commands.

High Speed ASCII IC and rich function (Text support, draw pixel, draw Line, draw Arc, draw Rectangle) design will make the user's product success.

- (1) Construction : a-Si TFT-LCD with driving system, White LED Backlight.
- (2) LCD type : Transmissive , Normally White
- (3) Number of the Colors : 262K colors (R,G,B 6 bit digital each)

2.Application Diagram

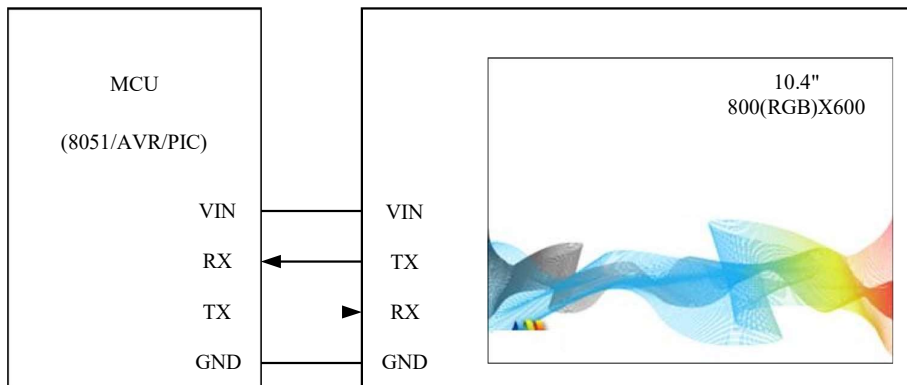

Any MCU which is with UART interface can control the TFT module.

3. PHYSICAL SPECIFICATIONS

Item	Specifications	unit
Display resolution	800RGB (W) x 600(H)	dots
Display size	10.4" (diagonal)	inch
Viewing Angle	6 o'clock (Gray Inversion)	-
Active area	211.2 (W) x 158.4(H)	mm
Pixel pitch	0.264 (W) x 0.264 (H)	um
Color configuration	R.G.B -stripe	-
Overall dimension	236.0(W) x 176.9(H) x 21.3(D)	mm
Backlight unit	LED	-
Brightness	500	cd/m2
Display color	262,144	colors
Contrast ratio	500	-

4. ABSOLUTE MAXIMUM RATINGS

Item	Symbol	Condition	Min.	Max.	Unit	Remark
Power voltage	(Vin)	GND=0	-0.3	26.0	V	
Input voltage			-0.3	3.6	V	Note 1

Note1: RXD, TXD

4.1.Environmental Absolute max. ratings

Item	OPERATING		STORAGE		Remark
	MIN	MAX	MIN	MAX	
Temperature	-20	70	-30	80	
Corrosive Gas	Not Acceptable		Not Acceptable		

Note1 : Ta <= 40°C : 85% RH max

Ta > 40°C : Absolute humidity must be lower than the humidity of 85%RH at 40°C

4.2 Electrical characteristics

4.2.1 DC Electrical characteristic

Typical operating conditions (GND=0V)

Item	Symbol	Min.	Typ.	Max.	Unit	Remark	
Power supply	V _{in}	4.6	--	26.0	V		
RS232 Input Voltage (Negative Logic)	H Level	V _{IH}	-15	--	-3	V	Note 1
	L Level	V _{IL}	+3	--	+15	V	
Input Voltage for logic	H Level	V _{IH}	0.7 VDD	-	VDD	V	
	L Level	V _{IL}	0	-	0.3 VDD	V	
Power Supply current	I _{DD}	--	850	--	mA	Note 2	
Power consumption	P		2.7		W		

Note1:RXD0,TXD0,RXD1,TXD1.

Note2: The internal power circuit will transfer the V_{in} to VDD=+3.3V for the module power, LED Backlight turn ON.

5. Electrical CHARACTERISTICS

Item		Min.	Typ.	Max.	Unit	Remark
Processor performance	GPU	--	80	--	MHz	
	CPU	--	100	--	MHz	
	L1 Cache (8nS Register)		512		Bytes	
	L2 Cache (10nS SRAM)		8		KB	
Storage	UART Buffer		32		KB	
	Display Buffer		1024		KB	
	Flash Memory:		128		MB	
	Flash Memory: Font		32		MB	
	Flash Memory: Picture	64		94	MB	
	Flash Memory: User Data	0		32	MB	

	Item	Min.	Typ.	Max.	Unit	Remark
Uart Speed	COM1 (3.3V CMOS) User interface	1200		115200	bps	
	COM2 (3.3V CMOS) Function expand	--	115200	--	bps	
LCD Interface	CLOCK_H	10	25	33	MHz	
	CLOCK_L	1	5	10	MHz	
	VOH (IOH=-100uA)	0.9VLCD	--	--	V	
	VOL(IOL=100uA)	--	--	0.2 VLCD	V	
	IO	-20		+20	mA	
	Resolution		640*480	800*600	Dots	
	Color mode	16 bit, R5G6B5				
	ESD(HBM)		2		KV	

6. Optical Specification

Item	Symbol	Conditions	Min	Typ	Max	Unit	Note	
Contrast Ration	CR	Viewing normal angle	-	500	-	-	(2)	
Response Time	TR	$\theta_x = \theta_y = 0$	-	5	10	ms	(1)	
	TF		-	15	20	ms		
Viewing Angle	Hor.	Center CR>10	θ_{x+}	-	70	-	deg	(4)
			θ_{x-}	-	70	-	deg	
	Ver.		θ_{y+}	-	50	-	deg	
			θ_{y-}	-	60	-	deg	
Module Chromaticity	Red	Viewing normal angle $\theta_x = \theta_y = 0$	XR	0.550	0.600	0.650		
			YR	0.294	0.344	0.394		
	Green		XG	0.304	0.354	0.404		
			YG	0.529	0.579	0.629		
	Blue		XB	0.105	0.155	0.205		
			YB	0.076	0.126	0.176		
	White		XW	0.240	0.290	0.340		
			YW	0.268	0.318	0.368		
Brightness	-	I _F =120mA	400	500	-	cd/m ²	(3)	

(1) Definition of Response Time (White-Black)

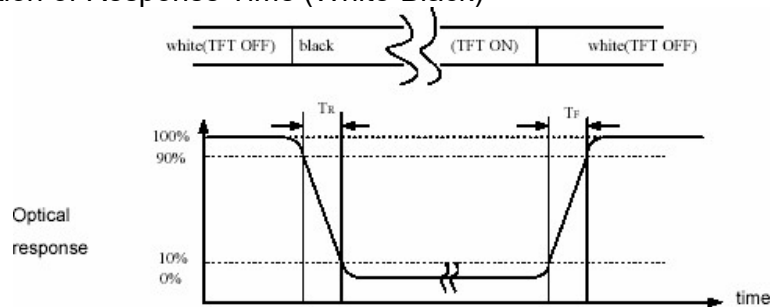

(2) Definition of Contrast Ratio

Measure contrast ratio on the below 5 points(refer to figure1,#1~#5point) and take the average value

Contrast ratio is calculated with the following formula :

$$\text{Contrast Ratio(CR)} = (\text{White})\text{Luminance of ON} \div (\text{Black})\text{Luminance of OFF}$$

(3) Definition of Luminance :

Measure the luminance of white state at **center point**.

(4) Definition of Viewing Angle

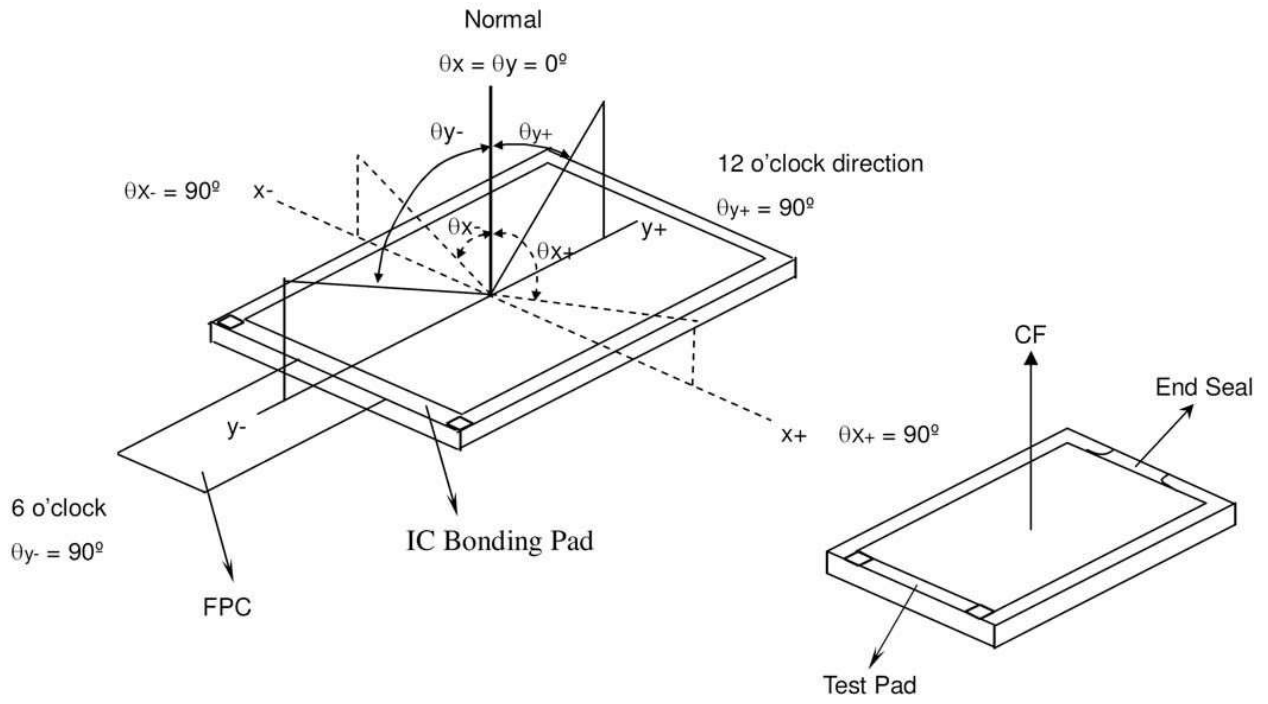

7. Block Diagram

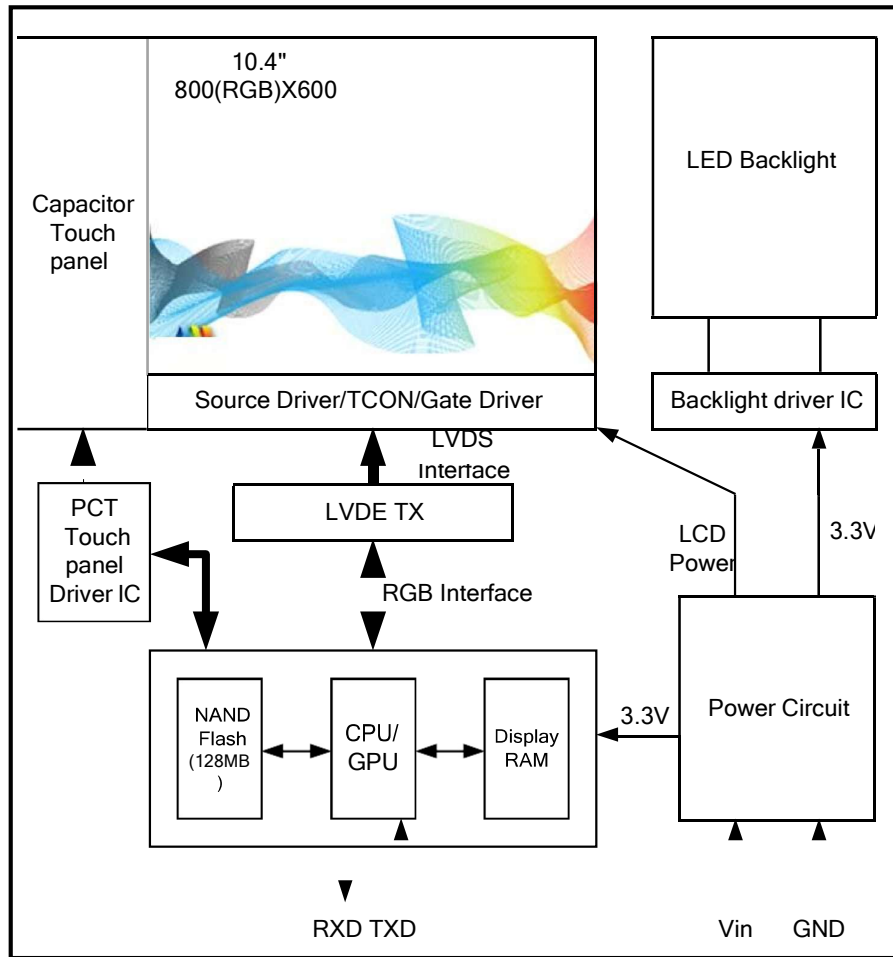

7.1 Jumper Setting :

Operation mode	Jumper Setting		Remark
	RA1	RA2	
UART/USB Mode	Short	OPEN	UART Mode: 1200~115200 can be selected Touch Panel Workable USB Mode: BPS: 921600 is fixed Touch Panel can not work
RS232 Mode	OPEN	Short	1200~115200 can be selected Touch Panel Workable

Note : The on board USB connector is USB B type

Note : Entry of USB mode must be USB connection with 5V before power on. If not, It will be entry of UART mode.



8.INTERFACE

8 Pins Pitch 2.54 connector				
PIN	Name	I/O	Description	Remark
1	Vin	P	Power input pin for the module (4.6~26V)	
2	Vin	P	Power input pin for the module (4.6~26V)	
3	/BUSY	O	Hi : Idle. The user can send the data to module. Lo: Busy. The data will be lost.	Note1
4	TXD	O	User UART serial signal output	
5	RXD	I	User UART serial signal input	
7	GND	P	Power and signal Ground	
8	GND	P	Power and signal Ground	

Note 1: The /BUSY=1 indicates that the internal GPU/CPU can accept at least a “**Command Frame**”. The /BUSY=0 indicates that the interface board can’t accept any “**Command Frame**”. The user can ignore the /BUSY signal unless the user use the “**Command Frame End**” and send lots “**Command Frame**” over the UART buffer.

9. Software Command SET

9.1 Basic Agreement

9.1.1 UART default Parameters

The default parameters of UART are:

Baudrate: 115200 bps (1200~115200 can be selected)

No of Stop Bits..... 1

Parity..... Off

Handshake None

9.1.2 Serial port data frame structure (Hex mode)

The “Serial port data frame structure” includes **Start Character**, **Command**, **Data Pack** and **End Characters**.

The command Frame start with “**Start Character 0xAA**”. And the follow byte is **Command Byte**, **Data Pack**. The “**End Byte**” is 0xCC 0x33 0xC3 0X3C. The user can add “Delay time” instead of the End Byte. But if the “End Byte” has been send, the “Delay time “ lose efficacy.

Structure	Start Character	Command	Data Pack	End Characters
Length(Byte)	1	1	0-249	4
	0XAA	One Byte (see command Set)	Relative Data (max 249 bytes)	0xCC 0x33 0xC3 0x3C Or add the Delay time

Baudrate_Set	Baudrate (bps)	Relative Delay Time
0x00	1200	12.5mS
0x01	2400	6.25mS
0X02	4800	3mS
0X03	9600	3mS
0X04	19200	2mS
0X05	38400	2mS
0X06	57600	1mS
0X07	115200	1mS

9.2 Command SET (Hex mode)

All the command description is hexadecimal format (HEX).

The X,Y coordinate express two bytes. High byte(MSB) + Low byte(LSB).

EX : X=10 (0x000A), The user must send the 0x00 0x0A.

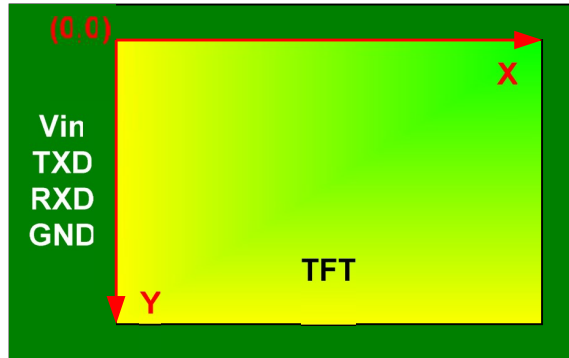

9.2.2 Configuration Command

Start Byte	Command Byte	Data Bytes	End Byte
0XAA	0xE0	0x55 0xAA 0x5A 0xA5 +TFT_ID+ Baudrate_Set +0x00	0xCC 0x33 0xC3 0x3C Or add the Delay time

Description: Set the TFT _ ID, UART Baudrate,

Class: Multi Byte Command

Code: E0hex, 224dec

TFT _ ID:

TFT_ID	Resolution	Mode	Picture	Remark
0x04	800x480	SYNC	128	HM800480E
0x0A / 0x01	640x480	SYNC	153	HM640480G2
0x0D	800x600	SYNC	96	HM800600G2
0x0D	800x600	SYNC	96	HM800640-34-0

Baudrate_Set:

Baudrate_Set	Baudrate (bps)	Relative Delay Time
0x00	1200	12.5mS
0x01	2400	6.25mS
0X02	4800	3mS
0X03	9600	3mS
0X04	19200	2mS
0X05	38400	2mS
0X06	57600	1mS
0X07	115200	1mS

Example : HM320240N/N1 , Baud rate 115200bps.

RXD0 Input : AA E0 55 AA 5A A5 0B 07 00

TXD0 Output : AA E0 0B 07 00 CC 33 C3 3C

Note: The default Baud rate is 115200 N, 8 , 1 between power on 0~200mS , after 200mS the baud rate is set to user setting.

9.2.3 Hand Shake Command

Start Byte	Command Byte	Data Bytes	End Byte
0XAA	0x00	None	0xCC 0x33 0xC3 0x3C Or add the Delay time

Description: Check the interface board communication

Class: Single Byte Command

Code: 00hex, 00dec

Example : The Output information depend on configuration.

RXD0 Input : AA 00

TXD0 Output: AA 00 “OK_V3.10” 0B 07 00 CC 33 C3 3C

Note: The power on reset time is 0.5~2 seconds.

9.2.4 Display Mode Setting

9.2.4.1 SET_COLOR

Start Byte	Command Byte	Data Bytes	End Byte
0XAA	0x40	Front Color MSB Front Color LSB BK Color MSB BK Color MSB	0xCC 0x33 0xC3 0x3C Or add the Delay time

Description: Set Front Color and Back Color. The Color data is 16 bits (0x0000~0xFFFF). The default Front color is 0xFFFF(White) and the Background color is 0x001F (Blue).

Class: Multi Byte Command

Code: 40hex, 64dec

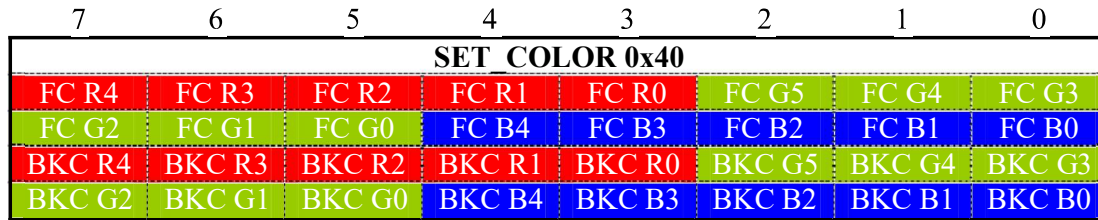

Example : Set the Front color =0xFFFF(White) and Background color is 0x001F (Blue).

RXD0 Input : AA 40 FF FF 00 1F

TXD0 Output: None

9.2.4.2 SET_FONT_PITCH

Start Byte	Command Byte	Data Bytes	End Byte
0XAA	0x41	PITCH_X PITCH_Y	0xCC 0x33 0xC3 0x3C Or add the Delay time

Description: Set the character FONT display pitch. PITCH_X and PITCH_Y can't set over than 0x7F.

The default PITCH_X= PITCH_Y=0

Class: Multi Byte Command

Code: 41hex, 65dec

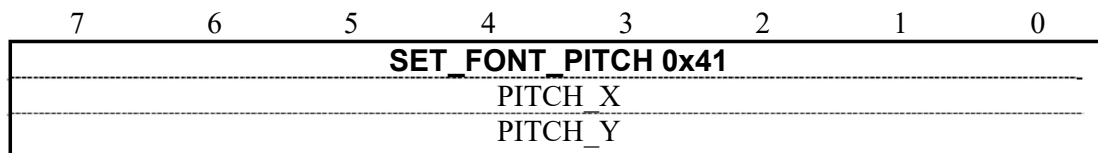

Example : Set PCITH_X=1,PITCHY=2.

RXD0 Input : AA 41 01 02

TXD0 Output: None

9.2.4.3 SET_BACKGROUND_COLOR By X,Y

Start Byte	Command Byte	Data Bytes	End Byte
0XAA	0x42	X MSB X LSB Y MSB Y MSB	0xCC 0x33 0xC3 0x3C Or add the Delay time

Description: Get the (X,Y) display color data and set to the Background color.

Class: Multi Byte Command

Code: 42hex, 66dec

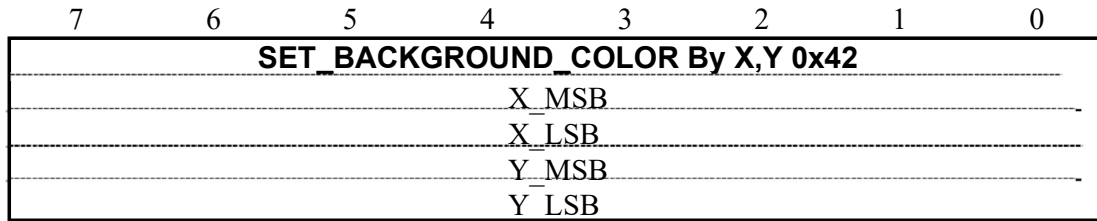

Example : Read the (X,Y)=(128,64) color data and set to the background color.

RXD0 Input : AA 42 00 80 00 40

TXD0 Output: None

9.2.4.4 SET_FRONT_COLOR By X,Y

Start Byte	Command Byte	Data Bytes	End Byte
0XAA	0x43	X_MSB X_LSB Y_MSB Y_LSB	0xCC 0x33 0xC3 0x3C Or add the Delay time

Description: Get the (X,Y) display color data and set to the Front color.

Class: Multi Byte Command

Code: 43hex, 67dec

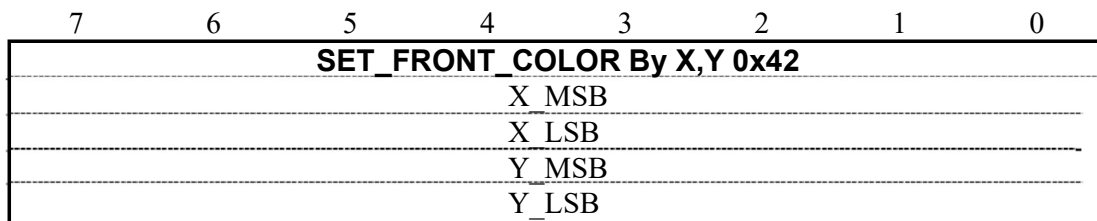

Example : Read the (X,Y)=(128,64) color data and set to the Front color.

RXD0 Input : AA 43 00 80 00 40

TXD0 Output: None

9.2.4.5 SET_CURSOR_MODE

Start Byte	Command Byte	Data Bytes	End Byte
0XAA	0x44	Mode X MSB X LSB Y MSB Y LSB Cursor Wide Cursor High	0xCC 0x33 0xC3 0x3C Or add the Delay time

Description: Set Cursor OFF (**Mode =0x00**) . Cursor ON (**Mode=0x01**). The (X,Y) is the left-up position of the cursor. Cursor Wide (0x01~0x1F) Cursor High (0x01~0x1F)

Class: Multi Byte Command

Code: 44hex, 68dec

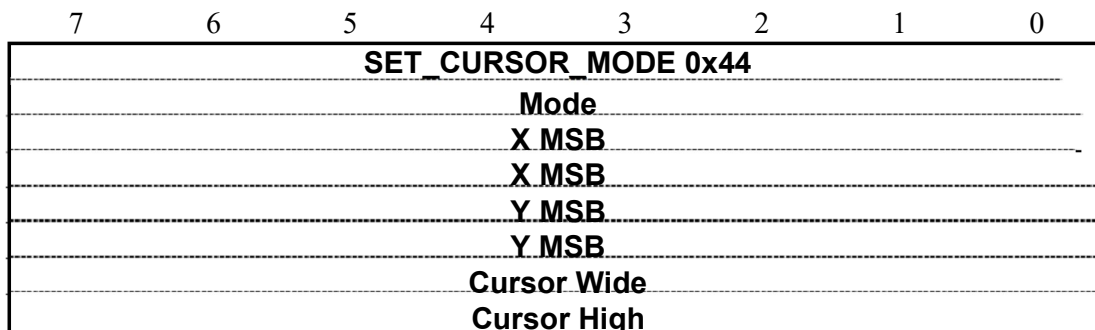

Example : Set Cursor ON, (X,Y)=(128,64) , Cursor Width=16 , Cursor High=4

RXD0 Input : AA 44 01 00 80 00 40 10 04

TXD0 Output: **None**

Text Display Command

9.2.4.6 PRINT_STRING_8x8 (Standard Font)

Start Byte	Command Byte	Data Bytes	End Byte
0XAA	0x53	X MSB X LSB Y MSB Y LSB "String"	0xCC 0x33 0xC3 0x3C Or add the Delay time

Description: Prints String. starting at (X,Y) Position

Class: Multi Byte Command

Code: 53hex, 83dec

7	6	5	4	3	2	1	0
PRINT_STRING 8x8 0x53							
X MSB							
X MSB							
Y MSB							
Y MSB							
ASCII							
ASCII							
~							
ASCII							
ASCII							

Example : Print 8x8 string “ LCD “ on (128,64).

RXD0 Input : AA 53 00 80 00 40 4C 43 44

PRINT_STRING_8x8 53 hex

XMSB 00 hex

XLSB 80 hex

YMSB 00 hex

YLSB 40 hex

'L' 4C hex

'C' 43 hex

'D' 44 hex

TXD0 Output: None

See also: [SET_COLOR](#) , [SET_BACKGROUND_COLOR By X,Y](#) , [SET_FRONT_COLOR By X,Y](#) , [SET_FONT_PITCH](#)

9.2.4.7 PRINT_STRING_16x16 (Standard Font)

Start Byte	Command Byte	Data Bytes	End Byte
0XAA	0x54	X MSB X LSB Y MSB Y LSB “String”	0xCC 0x33 0xC3 0x3C Or add the Delay time

Description: Prints String. start at (X,Y) Position

Class: Multi Byte Command

Code: 54hex, 84dec

7	6	5	4	3	2	1	0
PRINT_STRING 16x16 0x54							
X MSB							
X MSB							
Y MSB							
Y MSB							
ASCII							
ASCII							
~							
ASCII							
ASCII							

Example : Print 16x16 string “ LCD “ on (128,64).

RXD0 Input : **AA 54 00 80 00 40 4C 43 44**

PRINT_STRING_16x16 54 hex

XMSB 00 hex

XLSB 80 hex

YMSB 00 hex

YLSB 40 hex

'L' 4C hex

'C' 43 hex

'D' 44 hex

TXD0 Output: **None**

See also: [SET_COLOR](#) , [SET_BACKGROUND_COLOR By X,Y](#) , [SET_FRONT_COLOR By X,Y](#) , [SET_FONT_PITCH](#)

9.2.4.8 PRINT_STRING_32x32 (Standard Font)

Start Byte	Command Byte	Data Bytes	End Byte
0XAA	0x55	X MSB X LSB Y MSB Y LSB “String”	0xCC 0x33 0xC3 0x3C Or add the Delay time

Description: Prints String. starting at (X,Y) Position (Support GBK3212 FONT code)

Class: Multi Byte Command

Code: 55hex, 85dec

7	6	5	4	3	2	1	0
PRINT_STRING 32x32 0x55							
X MSB							
X MSB							
Y MSB							
Y MSB							
ASCII							
ASCII							
~							
ASCII							
ASCII							

Example : Print 32x32 string “ LCD “ on (128,64).

RXD0 Input : **AA 55 00 80 00 40 4C 43 44**

PRINT_STRING_32x32 55 hex

XMSB 00 hex

XLSB 80 hex

YMSB 00 hex

YLSB 40 hex

'L' 4C hex

'C' 43 hex

'D' 44 hex

TXD0 Output: **None**

See also: [SET_COLOR](#) , [SET_BACKGROUND_COLOR By X,Y](#) , [SET_FRONT_COLOR By X,Y](#) , [SET_FONT_PITCH](#)

9.2.4.9 PRINT_STRING_12x12(Standard Font)

Start Byte	Command Byte	Data Bytes	End Byte
0XAA	0x6E	X MSB X LSB Y MSB Y LSB “String”	0xCC 0x33 0xC3 0x3C Or add the Delay time

Description: Prints String. starting at (X,Y) Position

Class: Multi Byte Command

Code: 6Ehex, 110dec

7	6	5	4	3	2	1	0
PRINT_STRING_12x12_0x6E							
X MSB							
X MSB							
Y MSB							
Y MSB							
ASCII							
ASCII							
~							
ASCII							
ASCII							

Example : Print 12x12 string “ LCD “ on (128,64).

RXD0 Input : **AA 6E 00 80 00 40 4C 43 44**

PRINT_STRING_12x12_6E hex

XMSB 00 hex

XLSB 80 hex

YMSB 00 hex

YLSB 40 hex

'L' 4C hex

'C' 43 hex

'D' 44 hex

TXD0 Output: **None**

See also: [SET_COLOR](#) , [SET_BACKGROUND_COLOR By X,Y](#) , [SET_FRONT_COLOR By X,Y](#) , [SET_FONT_PITCH](#)

9.2.4.10 PRINT_STRING_24x24 (Standard Font)

Start Byte	Command Byte	Data Bytes	End Byte
0XAA	0x6F	X MSB X LSB Y MSB Y LSB “String”	0xCC 0x33 0xC3 0x3C Or add the Delay time

Description: Prints String. starting at (X,Y) Position

Class: Multi Byte Command

Code: 6Fhex, 111dec

7	6	5	4	3	2	1	0
PRINT_STRING 24x24 0x6F							
X MSB							
X MSB							
Y MSB							
Y MSB							
ASCII							
ASCII							
~							
ASCII							
ASCII							

Example : Print 24x24 string “ LCD “ on (128,64).

RXD0 Input : **AA 6F 00 80 00 40 4C 43 44**

PRINT_STRING_24x24 6F hex

XMSB 00 hex

XLSB 80 hex

YMSB 00 hex

YLSB 40 hex

'L' 4C hex

'C' 43 hex

'D' 44 hex

TXD0 Output: **None**

See also: [SET_COLOR](#) , [SET_BACKGROUND_COLOR By X,Y](#) , [SET_FRONT_COLOR By X,Y](#) , [SET_FONT_PITCH](#)

9.2.4.11 PRINT_STRING (Custom Font Library)

Start Byte	Command Byte	Data Bytes	End Byte
0XAA	0x98	X MSB X LSB Y MSB Y LSB Lib_ID C_mode C_dots Color Bcolor "String"	0xCC 0x33 0xC3 0x3C Or add the Delay time

Description: Prints String custom font starting at (X,Y) Position

Class: Multi Byte Command

Code: 98hex, 152dec

Lib_ID : 0x00~0x3B , Font library ID. The memory size of the font library is 32MB. The memory is arranged as 60 areas.

Lib_ID	Size	Description	Default
0x00~0x1F	128KB	There are 32 areas for small font library which size is 128KB. The user can download different style for ASCII code or small ICON	0x00=ASCII standard font library, please don't modify it. 0x01~0x1F: Free
0x20~0x3B	1MB	There are 28 areas for large font library which size is 1MB. <ul style="list-style-type: none"> Single area can be set as 12x12 or 16x16 (GBK encode) The area can be combined for super large font library. 	0x20=12x12 GBK 0x21=16x16 GBK 0x22=24x24 GB2312 0x23=32x32 GB2312 0x24~0x3B : Free

C_Mode : The mode of the character font:

Bit No	Bit7~Bit4	Bit3~Bit0
Definition	Display mode	Lib_Type(0x00~0x0F)
Description	Bit7=1: Front color is displayed Bit7=0: Front color is not displayed Bit6=1: Back ground color is displayed Bit6=0: Back ground color is not displayed Bit5 , Bit4 : don't care	Lib_Type define the encoding systems of the font : 0= 8bit 1=GB2312 2=GBK or HANGUL 3=BIG5 4=SJIS 5=UNICODE 6-F: undefined

C_dots : The display font size. (See the detail information: Custom Font Definition)

C_dots	C_Mode (Bit3~Bit0)		
	0 or 5	1, 2, 3, 4	
		ASCII	Chinese/Korea/Japan
0x00	8x8	6x12	12x12
0x01	6x12	8x16	16x16
0x02	8x16	12x24	24x24
0x03	12x24	16x32	32x32
0x04	16x32	20x40	40x40
0x05	20x40	24x48	48x48
0x06	24x48	28x56	56x56
0x07	28x58	32x64	64x64
0x08	32x64		
0x09	12x12		
0x0A	16x16		
0x0B	24x24		
0x0C	32x32		
0x0D	40x40		
0x0E	48x48		
0x0F	56x56		
0x10	64x64		
0x11	40x80		
0x12	48x96		
0x13	56x112		
0x14	64x128		
0x15	80x80		
0x16	96x96		
0x17	112x112		
0x18	128x128		

Color : The color of the font.

Bcolor : The background color of the font.

String : The encoding system is defined by C_Mode (Bit3~Bit0). If C_Mode=0,1,2,3and 4, the code identify as " ASCII " and showed by Lib_ID= 0.

7	6	5	4	3	2	1	0
PRINT_STRING Custom Font							
X MSB							
X MSB							
Y MSB							
Y MSB							
Lib ID							
C mode							
C dots							
Color							
Bcolor							
Font code							
Font code							
~							
Font code							
Font code							

RXD0 Input :

AA 98 00 80 00 40 24 C3 02 FF FF 00 00 41 4D 50 49 52 45 B4 B9 AA F6 A5 FA B9 71 CC 33 C3 3C

AA: Start Byte

98: command Byte

00 80 : X position

00 40 : Y position

24 : Lib_ID (The user must to download the BIG5_24x24 to 0x24)

C3 : C_mode Front color is displayed , Back ground color is displayed , BIG5

02 : C_dots , ASCII size :12x24 , Chinese : 24x24

FF FF : Color is white

00 00 : Bcolor , background color is black.

41 4D 50 49 52 45

B4 B9 AA F6 A5 FA B9 71

CC 33 C3 3C: End Byte

TXD0 Output: **None**

See also: [SET_COLOR](#) , [SET_BACKGROUND_COLOR By X,Y](#) , [SET_FRONT_COLOR By X,Y](#) , [SET_FONT_PITCH](#)

9.2.5 Put pixel Command

9.2.5.1 Put Pixel by Background Color

Start Byte	Command Byte	Data Bytes	End Byte
0XAA	0x50	X ₀ MSB X ₀ LSB Y ₀ MSB Y ₀ LSB X ₁ MSB X ₁ LSB Y ₁ MSB Y ₁ LSB ~~ X _k MSB X _k LSB Y _k MSB Y _k LSB	0xCC 0x33 0xC3 0x3C Or add the Delay time

Description: Put the background color to the point (X₀,Y₀) , (X₁,Y₁) ,... (X_k,Y_k)

Class: Multi Byte Command

Code: 50hex, 80dec

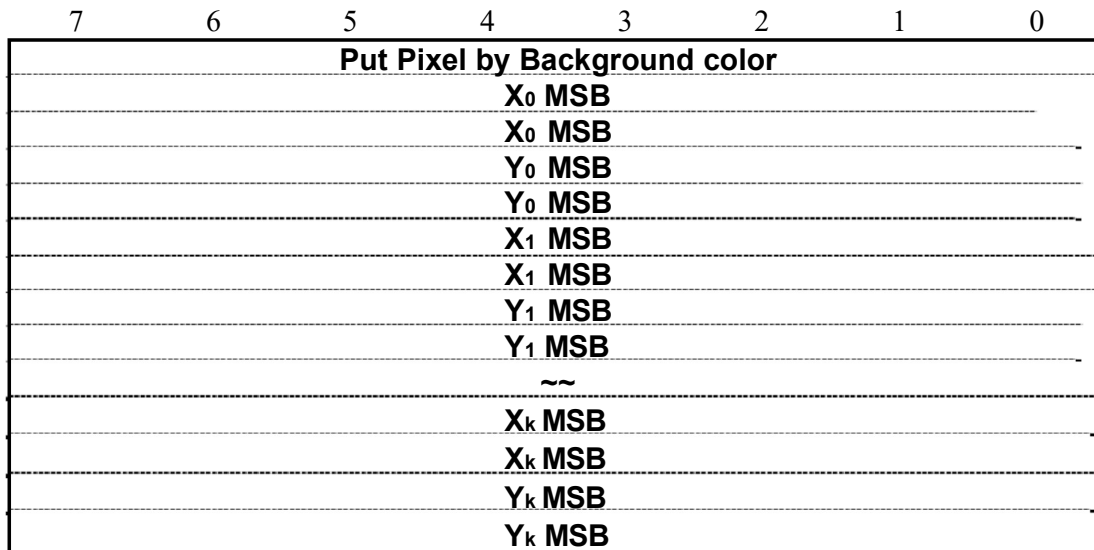

Example : Put pixel by background color on (0,0) (1,1) (2,2)

RXD0 Input : AA 50 00 00 00 00 00 01 00 01 00 02 00 02 CC 33 C3 3C

AA: Start Byte

50: command Byte

00 00 00 00 : (X, Y)=(0,0)

00 01 00 01 : (X, Y)=(1,1)

00 02 00 02 : (X, Y)=(2,2)

CC 33 C3 3C: End Byte

TXD0 Output: None

See also: [SET COLOR](#) , [SET BACKGROUND COLOR By X.Y](#)

9.2.5.2 Put Pixel by Front Color

Start Byte	Command Byte	Data Bytes	End Byte
0XAA	0x51	X ₀ MSB X ₀ LSB Y ₀ MSB Y ₀ LSB X ₁ MSB X ₁ LSB Y ₁ MSB Y ₁ LSB ~~ X _k MSB X _k LSB Y _k MSB Y _k LSB	0xCC 0x33 0xC3 0x3C Or add the Delay time

Description: Put the front color to the point (X₀,Y₀) , (X₁,Y₁) ,... (X_k,Y_k)

Class: Multi Byte Command

Code: 51hex, 81dec

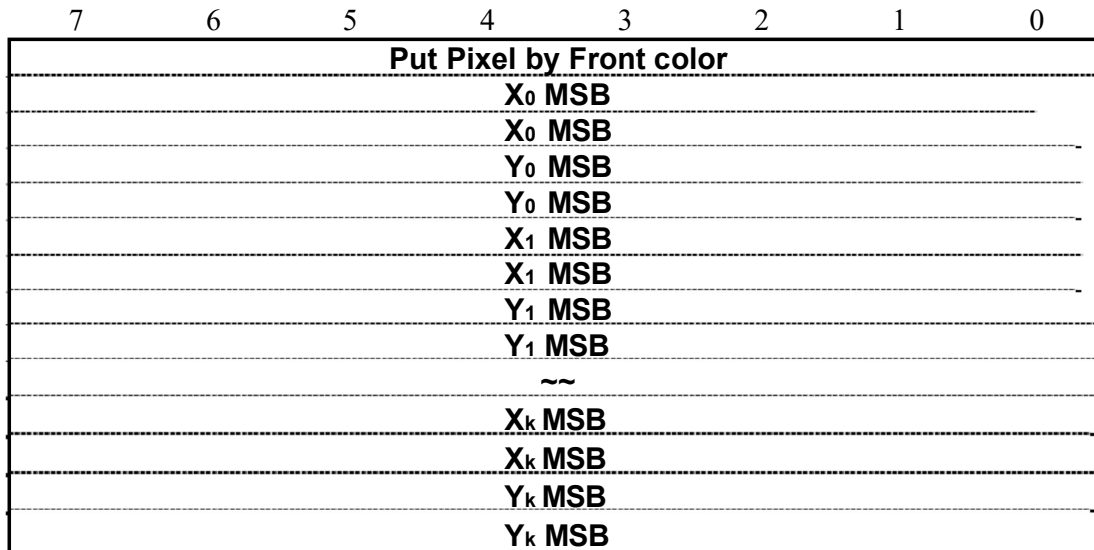

Example : Put pixel by front color on (0,0) (1,1) (2,2)

RXD0 Input : AA 51 00 00 00 00 01 00 01 00 02 00 02 CC 33 C3 3C

AA: Start Byte

50: command Byte

00 00 00 00 : (X, Y) = (0, 0)

00 01 00 01 : (X, Y) = (1, 1)

00 02 00 02 : (X, Y) = (2, 2)

CC 33 C3 3C: End Byte

TXD0 Output: **None**

See also: [SET COLOR](#) , [SET FRONT COLOR By X,Y](#)

9.2.5.3 Put Pixel and Clear vertical line by specify color

Start Byte	Command Byte	Data Bytes	End Byte
0XAA	0x74	X MSB X LSB Ys MSB Ys LSB YE MSB YE LSB Clear Color MSB Clear Color LSB Y1 MSB Y1 LSB Color(X,Y1) MSB Color(X,Y1) LSB Y2 MSB Y2 LSB Color(X,Y2) MSB Color(X,Y2) LSB ~~ Yk MSB Yk LSB Color(X,Yk) MSB Color(X,Yk) LSB	0xCC 0x33 0xC3 0x3C Or add the Delay time

Description: This command is for motion curve application. This command include two actions.

- Draw a vertical line on (X ,Ys) (X ,YE) by **Clear Color**
- Put (X,Y1) by **Color (X,Y1)** , Put (X,Y2) by **Color (X,Y2)**and Put (X,Yk) by **Color (X,Yk)**.

Class: Multi Byte Command

Code: 74hex, 116 dec

Example :

Clear line (5,0) (5,255) by Black 0x0000

Put (5, 0) by Red 0xF800

Put (5, 16) by Green 0x07E0

Put (5, 32) by Blue 0x001F

Put (5, 48) by White 0xFFFF

RXD0 Input : AA 74 00 05 00 00 00 FF 00 00 00 00 F8 00 00 10 07 E0 00 20 00 1F 00 30 FF FF
CC 33 C3 3C

AA: Start Byte

```

74: command Byte
00 05 : X = 5
00 00 : YS= 0
00 FF : YE= 255
00 00 : Clear Color = Black 0x0000
00 00 : Y1 = 0
F8 00 : (X,Y1) color = Red 0xF800
00 10 : Y2 = 16
07 E0 : (X,Y2) color = Green 0x07E0
00 20 : Y3 = 32
00 1F : (X,Y3) color = Blue 0x001F
00 30 : Y4 = 48
00 1F : (X,Y4) color = White 0xFFFF
CC 33 C3 3C: End Byte
TXD0 Output: None

```

9.2.6 Draw Line Command

9.2.6.1 Draw Front Color Lines by the specify points

Start Byte	Command Byte	Data Bytes	End Byte
0XAA	0x56	X ₀ MSB X ₀ LSB Y ₀ MSB Y ₀ LSB X ₁ MSB X ₁ LSB Y ₁ MSB Y ₁ LSB ~~ X _k MSB X _k LSB Y _k MSB Y _k LSB	0xCC 0x33 0xC3 0x3C Or add the Delay time

Description: Draw the line (X₀,Y₀) (X₁,Y₁)(X_k,Y_k)

Class: Multi Byte Command

Code: 56hex, 86dec

Example : To draw a triangle by front color . (0,0) (128,64) (128,0) (0,0)

RXD0 Input : **AA 56 00 00 00 00 00 80 00 40 00 80 00 00 00 00 00 00 CC 33 C3 3C**

AA: Start Byte

56: command Byte

00 00 00 00 : (X,Y)=(0,0)

```

00 80 00 40 : (X0,Y0)=(128,64)
00 80 00 00 : (X1,Y1)=(128,0)
00 00 00 00 : (X2,Y2)=(0,0)
CC 33 C3 3C: End Byte

```

TXD0 Output: **None**

See also: [SET_COLOR](#) , [SET_FRONT_COLOR By X.Y](#)

9.2.6.2 Draw Background Color Lines by the specify points

Start Byte	Command Byte	Data Bytes	End Byte
0XAA	0x5D	X ₀ MSB X ₀ LSB Y ₀ MSB Y ₀ LSB X ₁ MSB X ₁ LSB Y ₁ MSB Y ₁ LSB ~~ X _k MSB X _k LSB Y _k MSB Y _k LSB	0xCC 0x33 0xC3 0x3C Or add the Delay time

Description: Draw the line (X₀,Y₀) (X₁,Y₁)(X_k,Y_k)

Class: Multi Byte Command

Code: 56hex, 86dec

Example : To draw a triangle by background color. (0,0) (128,64) (128,0) (0,0)

RXD0 Input : AA 5D 00 00 00 00 00 80 00 40 00 80 00 00 00 00 00 00 CC 33 C3 3C

AA: Start Byte

56: command Byte

```

00 00 00 00 : (X,Y)=(0,0)
00 80 00 40 : (X0,Y0)=(128,64)
00 80 00 00 : (X1,Y1)=(128,0)
00 00 00 00 : (X2,Y2)=(0,0)
CC 33 C3 3C: End Byte

```

TXD0 Output: **None**

See also: [SET_COLOR](#) , [SET_BACKGROUND_COLOR By X.Y](#)

9.2.7 Draw Circle Command

9.2.7.1 Draw a Circle by the specified the radius and center points.

Start Byte	Command Byte	Data Bytes	End Byte
0XAA	0x57	TYPE X₀ MSB X₀ LSB Y₀ MSB Y₀ LSB R₀ ~~ TYPE X_k MSB X_k LSB Y_k MSB Y_k LSB R_k	0xCC 0x33 0xC3 0x3C Or add the Delay time

Description: Draw the Circle by the specify center (X₀,Y₀) , Radius R₀ .

Class: Multi Byte Command

Code: 56hex, 86dec

Type : Circle display mode .

Type=0 Reverse the color of the Circle

Type=1 Display the front color to the Circle

Type=2 Reverse the color of the full circle area

Type=3 Display the front color to the full circle area

Example : Reverse the color of the circle which radius = 100 and center (200,250)

RXD0 Input : AA 57 02 00 C8 00 FA 64 CC 33 C3 3C

AA: Start Byte

56: command Byte

00 00 00 00 : (X, Y)=(0, 0)

00 80 00 40 : (X₀, Y₀)=(128, 64)

00 80 00 00 : (X₁, Y₁)=(128, 0)

00 00 00 00 : (X₂, Y₂)=(0, 0)

CC 33 C3 3C: End Byte

TXD0 Output: **None**

See also: [SET COLOR](#) , [SET FRONT COLOR By X,Y](#)

9.2.8 Draw Rectangle Command

9.2.8.1 Draw a front color Rectangle by the specified the left-up and right-down points.

Start Byte	Command Byte	Data Bytes	End Byte
0XAA	0x59	X _{s0} MSB X _{s0} LSB Y _{s0} MSB Y _{s0} LSB X _{E0} MSB X _{E0} LSB Y _{E0} MSB Y _{E0} LSB ~~ X _{Sk} MSB X _{Sk} LSB Y _{Sk} MSB Y _{Sk} LSB X _{Ek} MSB X _{Ek} LSB Y _{Ek} MSB Y _{Ek} LSB	0xCC 0x33 0xC3 0x3C Or add the Delay time

Description: Draw the front color Rectangle by the specify the left-up point (X_{s0},Y_{s0}) , Right-Down points(X_{E0},Y_{E0}) .

Class: Multi Byte Command

Code: 59hex, 89dec

Example : Draw the two Rectangle. One is the left-up point (64,64) and Right-Down points(128,128) . The other one is the left-up point (10,10) and Right-Down points (20,20) .

RXD0 Input : AA 59 00 40 00 40 00 80 00 80 00 0A 00 0A 00 14 00 14 CC 33 C3 3C

AA: Start Byte

59: command Byte

00 40 00 40 : (X_{S0},Y_{S0})=(64,64)

00 80 00 80 : (X_{E0},Y_{E0})=(128,64)

00 0A 00 0A : (X_{S1},Y_{S1})=(10,10)

00 14 00 14 : (X_{S1},Y_{S1})=(20,20)

CC 33 C3 3C: End Byte

TXD0 Output: **None**

See also: [SET_COLOR](#) , [SET_FRONT_COLOR By X.Y](#)

9.2.8.2 Draw a background color Rectangle by the specified the left-up and right-down points.

Start Byte	Command Byte	Data Bytes	End Byte
0XAA	0x69	X _{S0} MSB X _{S0} LSB Y _{S0} MSB Y _{S0} LSB X _{E0} MSB X _{E0} LSB Y _{E0} MSB Y _{E0} LSB ~~ X _{Sk} MSB X _{Sk} LSB Y _{Sk} MSB Y _{Sk} LSB X _{Ek} MSB X _{Ek} LSB Y _{Ek} MSB Y _{Ek} LSB	0xCC 0x33 0xC3 0x3C Or add the Delay time

Description: Draw the background color Rectangle by the specify the left-up point (X_{S0},Y_{S0}) , Right-Down points(X_{E0},Y_{E0}) .

Class: Multi Byte Command

Code: 69hex, 105dec

Example : Draw the two Rectangle. One is the left-up point (64,64) and Right-Down points(128,128) . The other one is the left-up point (10,10) and Right-Down points (20,20) .

RXD0 Input : AA 69 00 40 00 40 00 80 00 80 00 0A 00 0A 00 14 00 14 CC 33 C3 3C

AA: Start Byte

69: command Byte

00 40 00 40 : (X_{S0},Y_{S0})=(64,64)

00 80 00 80 : (X_{E0},Y_{E0})=(128,64)

00 0A 00 0A : (X_{S1},Y_{S1})=(10,10)

00 14 00 14 : (X_{S1},Y_{S1})=(20,20)

CC 33 C3 3C: End Byte

TXD0 Output: None

See also: [SET_COLOR](#) , [SET_BACKGROUND_COLOR By X.Y](#)

9.2.9 Full Area Command

9.2.9.1 Clear Screen

Start Byte	Command Byte	Data Bytes	End Byte
0XAA	0x52	None	0xCC 0x33 0xC3 0x3C Or add the Delay time

Description: Clear the LCD with the background color.

Class: None Byte Command

Code: 52hex, 82dec

Example : Clear the LCD with the background color.

RXD0 Input : AA 52 CC 33 C3 3C

AA: Start Byte

52: command Byte

CC 33 C3 3C: End Byte

TXD0 Output: None

See also: [SET COLOR](#) , [SET BACKGROUND COLOR By X.Y](#)

9.2.9.2 Full area with Background color

Start Byte	Command Byte	Data Bytes	End Byte
0XAA	0x5A	X _{S0} MSB X _{S0} LSB Y _{S0} MSB Y _{S0} LSB X _{E0} MSB X _{E0} LSB Y _{E0} MSB Y _{E0} LSB ~~ X _{Sk} MSB X _{Sk} LSB Y _{Sk} MSB Y _{Sk} LSB X _{Ek} MSB X _{Ek} LSB Y _{Ek} MSB Y _{Ek} LSB	0xCC 0x33 0xC3 0x3C Or add the Delay time

Description: Full the Rectangle with background color by the specify the left-up point (X_{S0}, Y_{S0}) , Right-Down points(X_{E0}, Y_{E0}) .

Class: Multi Byte Command

Code: 5Ahex, 90dec

Example : Full two Rectangle with background color . One is left-up point(0,0) and Right-Down points (64,64). The other one is left-up point (160,128) and Right-Down points (240,160).

RXD0 Input : **AA 5A 00 00 00 00 40 00 40 00 A0 00 80 00 F0 00 A0 CC 33 C3 3C**

AA: Start Byte

5A: command Byte

00 00 00 00 : left-up point (0,0)

00 40 00 40 : Right-down point (64,64)

00 A0 00 80 : left-up point (160,128)

00 F0 00 A0 : Right-down point (240,160)

CC 33 C3 3C: End Byte

TXD0 Output: **None**

See also: [SET COLOR](#) , [SET BACKGROUND COLOR By X.Y](#)

9.2.9.3 Full area with Front color

Start Byte	Command Byte	Data Bytes	End Byte
0XAA	0x5B	X_{S0} MSB X_{S0} LSB Y_{S0} MSB Y_{S0} LSB X_{E0} MSB X_{E0} LSB Y_{E0} MSB Y_{E0} LSB ~~ X_{Sk} MSB X_{Sk} LSB Y_{Sk} MSB Y_{Sk} LSB X_{Ek} MSB X_{Ek} LSB Y_{Ek} MSB Y_{Ek} LSB	0xCC 0x33 0xC3 0x3C Or add the Delay time

Description: Full the Rectangle with front color by the specify the left-up point (X_{S0},Y_{S0}) , Right-Down points(X_{E0},Y_{E0}) .

Class: Multi Byte Command

Code: 5Bhex, 91dec

Example : Full two Rectangle with front color . One is left-up point(0,0) and Right-Down points (64,64). The other one is left-up point (160,128) and Right-Down points (240,160).

RXD0 Input : AA 5B 00 00 00 00 00 40 00 40 00 A0 00 80 00 F0 00 A0 CC 33 C3 3C

AA: Start Byte

5B: command Byte

00 00 00 00 : left-up point (0,0)

00 40 00 40 : Right-down point (64,64)

00 A0 00 80 : left-up point (160,128)

00 F0 00 A0 : Right-down point (240,160)

CC 33 C3 3C: End Byte

TXD0 Output: **None**

See also: [SET COLOR](#) , [SET FRONT COLOR By X.Y](#)

Reverse area color

Start Byte	Command Byte	Data Bytes	End Byte
0XAA	0x5C	X _{S0} MSB X _{S0} LSB Y _{S0} MSB Y _{S0} LSB X _{E0} MSB X _{E0} LSB Y _{E0} MSB Y _{E0} LSB ~~ X _{Sk} MSB X _{Sk} LSB Y _{Sk} MSB Y _{Sk} LSB X _{Ek} MSB X _{Ek} LSB Y _{Ek} MSB Y _{Ek} LSB	0xCC 0x33 0xC3 0x3C Or add the Delay time

Description: Reverse the area color by the specify the left-up point (X_{S0},Y_{S0}) , Right-Down points(X_{E0},Y_{E0}) .

Class: Multi Byte Command

Code: 5Chex, 92dec

Example : Reverse two areas color. One is left-up point (0,0) and Right-Down points (64,64). The other one is left-up point (160,128) and Right-Down points (240,160).

RXD0 Input : AA 5C 00 00 00 00 00 40 00 40 00 A0 00 80 00 F0 00 A0 CC 33 C3 3C

AA: Start Byte

5C: command Byte

00 00 00 00 : left-up point (0,0)

00 40 00 40 : Right-down point (64,64)

00 A0 00 80 : left-up point (160,128)
 00 F0 00 A0 : Right-down point (240,160)
 CC 33 C3 3C: End Byte

TXD0 Output: **None**

Move Area Command

9.2.9.4 Move area data to left N pixel by the specified the left-up and right-down points.

Start Byte	Command Byte	Data Bytes	End Byte
0XAA	0x60	X _{S0} MSB X _{S0} LSB Y _{S0} MSB Y _{S0} LSB X _{E0} MSB X _{E0} LSB Y _{E0} MSB Y _{E0} LSB N ₀ (N <=16) ~~ X _{Sk} MSB X _{Sk} LSB Y _{Sk} MSB Y _{Sk} LSB X _{E_k} MSB X _{E_k} LSB Y _{E_k} MSB Y _{E_k} LSB N _k (N <=16)	0xCC 0x33 0xC3 0x3C Or add the Delay time

Description: Move area data to left N pixel by the specify the left-up point (X_{S0},Y_{S0}) , Right-Down points(X_{E0},Y_{E0}) .

Class: Multi Byte Command

Code: 60hex, 96dec

Example : Move two areas data to left 16 pixels. One is the left-up point (64,64) and Right-Down points(128,128) . The other one is the left-up point (16,16) and Right-Down points (48,48) .

RXD0 Input :

AA 60 00 40 00 40 00 80 00 80 10 00 10 00 10 00 30 00 30 10 CC 33 C3 3C

AA: Start Byte

60: command Byte

00 40 00 40 : (X_{S0},Y_{S0})=(64,64)

00 80 00 80 : (X_{E0},Y_{E0})=(128,64)

00 10 00 10 : (XS1,YS1)=(16,16)

00 30 00 30 : (XS1,YS1)=(48,48)

CC 33 C3 3C: End Byte

TXD0 Output: **None**

9.2.9.5 Move area data to right N pixel by the specified the left-up and right-down points.

Start Byte	Command Byte	Data Bytes	End Byte
0XAA	0x61	X _{S0} MSB X _{S0} LSB Y _{S0} MSB Y _{S0} LSB X _{E0} MSB X _{E0} LSB Y _{E0} MSB Y _{E0} LSB N ₀ (N <=16) ~~ X _{Sk} MSB X _{Sk} LSB Y _{Sk} MSB Y _{Sk} LSB X _{E_k} MSB X _{E_k} LSB Y _{E_k} MSB Y _{E_k} LSB N _k (N <=16)	0xCC 0x33 0xC3 0x3C Or add the Delay time

Description: Move area data to right N pixel by the specify the left-up point (X_{S0},Y_{S0}) , Right-Down points(X_{E0},Y_{E0}) .

Class: Multi Byte Command

Code: 61hex, 97dec

Example : Move two areas data to right 16 pixels. One is the left-up point (64,64) and Right-Down points(128,128) . The other one is the left-up point (16,16) and Right-Down points (48,48) .

RXD0 Input :

AA 61 00 40 00 40 00 80 00 80 10 00 10 00 10 00 30 00 30 10 CC 33 C3 3C

AA: Start Byte

61: command Byte

00 40 00 40 : (XS0,YS0)=(64,64)

00 80 00 80 : (XE0,YE0)=(128,64)

00 10 00 10 : (XS1,YS1)=(16,16)

00 30 00 30 : (XS1,YS1)=(48,48)

CC 33 C3 3C: End Byte

TXD0 Output: **None**

9.2.9.6 Move area data to left N pixel by the specified the left-up and right-down points. And full the right N pixel with background color

Start Byte	Command Byte	Data Bytes	End Byte
0XAA	0x62	X _{S0} MSB X _{S0} LSB Y _{S0} MSB Y _{S0} LSB X _{E0} MSB X _{E0} LSB Y _{E0} MSB Y _{E0} LSB N ₀ (N <=16) ~~ X _{Sk} MSB X _{Sk} LSB Y _{Sk} MSB Y _{Sk} LSB X _{E_k} MSB X _{E_k} LSB Y _{E_k} MSB Y _{E_k} LSB N _k (N <=16)	0xCC 0x33 0xC3 0x3C Or add the Delay time

Description: Move area data to left N pixel by the specify the left-up point (X_{S0},Y_{S0}) , Right-Down points(X_{E0},Y_{E0}) . And full the right N pixel with background color.

Class: Multi Byte Command

Code: 62hex, 98dec

Example : Move two areas data to left 16 pixels. One is the left-up point (64,64) and Right-Down points(128,128) . The other one is the left-up point (16,16) and Right-Down points (48,48) .And full the right side 16 pixels with background color.

RXD0 Input :

AA 62 00 40 00 40 00 80 00 80 10 00 10 00 10 00 30 00 30 10 CC 33 C3 3C

AA: Start Byte

62: command Byte

00 40 00 40 : (XS0,YS0)=(64,64)

00 80 00 80 : (XE0,YE0)=(128,64)

00 10 00 10 : (XS1,YS1)=(16,16)

00 30 00 30 : (XS1,YS1)=(48,48)

CC 33 C3 3C: End Byte

TXD0 Output: **None**

See also: [SET COLOR](#) , [SET BACKGROUND COLOR By X.Y](#)

9.2.9.7 Move area data to right N pixel by the specified the left-up and right-down points. And full the left N pixel with background color

Start Byte	Command Byte	Data Bytes	End Byte
0XAA	0x63	X _{S0} MSB X _{S0} LSB Y _{S0} MSB Y _{S0} LSB X _{E0} MSB X _{E0} LSB Y _{E0} MSB Y _{E0} LSB N ₀ (N <=16) ~~ X _{Sk} MSB X _{Sk} LSB Y _{Sk} MSB Y _{Sk} LSB X _{Ek} MSB X _{Ek} LSB Y _{Ek} MSB Y _{Ek} LSB N _k (N <=16)	0xCC 0x33 0xC3 0x3C Or add the Delay time

Description: Move area data to right N pixel by the specify the left-up point (X_{S0},Y_{S0}) , Right-Down points(X_{E0},Y_{E0}) . And full the left N pixel with background color.

Class: Multi Byte Command

Code: 63hex, 99dec

Example : Move two areas data to right 16 pixels. One is the left-up point (64,64) and Right-Down points(128,128) . The other one is the left-up point (16,16) and Right-Down points (48,48) .And full the left side 16 pixels with background color.

RXD0 Input :

AA 63 00 40 00 40 00 80 00 80 10 00 10 00 10 00 30 00 30 10 CC 33 C3 3C

AA: Start Byte

63: command Byte

00 40 00 40 : (XS0,YS0)=(64,64)

```

00 80 00 80 : (XE0, YE0)=(128, 64)
00 10 00 10 : (XS1, YS1)=(16, 16)
00 30 00 30 : (XS1, YS1)=(48, 48)
CC 33 C3 3C: End Byte

```

TXD0 Output: **None**

See also: [SET COLOR](#) , [SET BACKGROUND COLOR By X.Y](#)

9.2.10 Picture Command

9.2.10.1 Show the full picture by specify the PICNUM

Start Byte	Command Byte	Data Bytes	End Byte
0XAA	0x70	PICNUM	0xCC 0x33 0xC3 0x3C Or add the Delay time

Description: The command will show the full picture which save in the picture flash memory by specify PICNUM.

Class: Single Byte Command

Code: 70hex, 112dec

Example : Show the picture which PICNUM=1.

RXD0 Input : **AA 70 01 CC 33 C3 3C**

AA: Start Byte

70: command Byte

01: PICNUM

CC 33 C3 3C: End Byte

TXD0 Output: **None**

9.2.10.2 Show the area of picture in position X,Y by specify the PICNUM , left-up and right-down points , X and Y.

Start Byte	Command Byte	Data Bytes	End Byte
0XAA	0x71	PICNUM X_{s0} MSB X_{s0} LSB Y_{s0} MSB Y_{s0} LSB X_{E0} MSB X_{E0} LSB Y_{E0} MSB Y_{E0} LSB X MSB X LSB Y MSB Y LSB	0xCC 0x33 0xC3 0x3C Or add the Delay time

Description: The command will show the area of the picture which left-up point (X_{s0},Y_{s0}) , Right-Down points(X_{E0},Y_{E0}) and PICNU in position X,Y.

Class: Multi Byte Command

Code: 71hex, 113dec

Example : Show the area of the picture which PICNUM=2 , left-up point (100,100) , Right-Down points(200,200) in the position (0,0).

RXD0 Input : AA 71 02 00 64 00 64 00 C8 00 C8 00 00 00 00 CC 33 C3 3C

AA: Start Byte

71: command Byte

02: PICNUM

00 64 00 64: left-up point (100,100)

00 C8 00 C8: right-down point (200,200)

00 00 00 00: Show on position (0,0)

CC 33 C3 3C: End Byte

TXD0 Output: **None**

9.2.10.3 Save the screen data to flash memory.

Start Byte	Command Byte	Data Bytes	End Byte
0XAA	0xE2	PICNUM	0xCC 0x33 0xC3 0x3C Or add the Delay time

Description: The command will save all the screen data to flash memory. The picture address is PICNUM.

Class: Single Byte Command

Code: E2hex, 226dec

Example : Save the screen data to PICNUM=2.

RXD0 Input : AA E2 02 CC 33 C3 3C

AA: Start Byte

E2: command Byte

02: save picture address PICNUM

CC 33 C3 3C: End Byte

TXD0 Output: **None**

Display RAM Command

9.2.10.4 Write data to the display RAM.

Start Byte	Command Byte	Data Bytes	End Byte
0XAA	0x72	ADR Bit23~Bit16 ADR Bit15~Bit8 ADR Bit7~Bit0 DATA0 DATA1 ~ DATA _n (n<=248)	0xCC 0x33 0xC3 0x3C Or add the Delay time

Description: The user can write the display RAM directly. The address range is 0x00000~0x7FFFF.

The width of the data is 16 bits.

Address = Resolution_X * Position_Y + Position_X.

EX: If the Display Resolution is 640x480. The address of position (80,100) is

640*100+80=64080(dec) = 0x0FA50(hex)

Class: Multi Byte Command

Code: 72hex, 114dec

Example : Write the Red(0xf800) color to the position (80,100) , Green (0x07E0) color to the position (81,100)

RXD0 Input :

AA 72 00 FA 50 F8 00 07 E0 CC 33 C3 3C

AA: Start Byte

72: command Byte

00 FA 50 : Display RAM Address.

F8 00 : Red data

07 E0 : Green data

CC 33 C3 3C: End Byte

TXD0 Output: **None**

IO control Command

9.2.10.5 SET I/O1 to Low

Start Byte	Command Byte	Data Bytes	End Byte
0XAA	0x5E	None	0xCC 0x33 0xC3 0x3C Or add the Delay time

Description: The user can set the I/O1 to Low by the command. When I/O1 connect to LED backlight driving circuit , the B/L will turn OFF.

Class: Single Byte Command

Code: 5Eex, 94dec

Example : Set I/O1=Low

RXD0 Input : **AA 5E CC 33 C3 3C**

AA: Start Byte

5E: command Byte

CC 33 C3 3C: End Byte

TXD0 Output: **None**

9.2.10.6 Back-light Dimming control I/O1

Start Byte	Command Byte	Data Bytes	End Byte
0XAA	0x5F	PWM_DUTY (0x00-0x40)	0xCC 0x33 0xC3 0x3C Or add the Delay time

Description: The LED Back-light dimming circuit connect to the I/O1. The PWM_DUTY(0x00~0x40) can be selected the brightness of the LED Back-light.

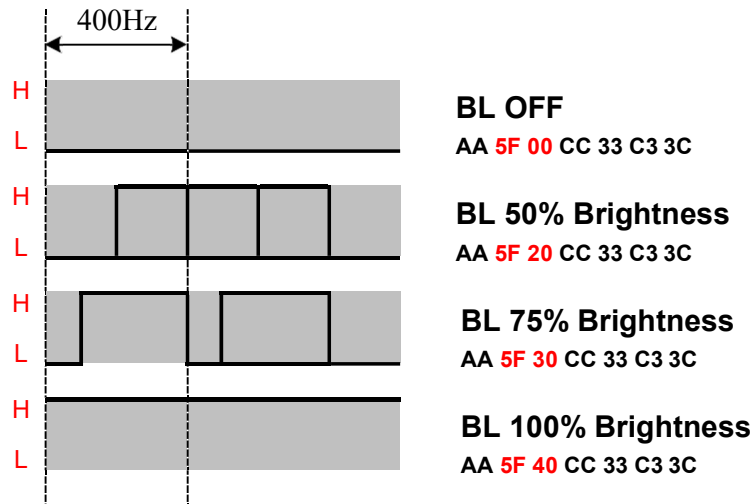

Class: Multi Byte Command

Code: 5Fhex, 94dec

Example : Set the LED brightness = 75%

RXD0 Input : AA 5F 30 CC 33 C3 3C

AA: Start Byte

5F: command Byte

30: PWM_DUTY

CC 33 C3 3C: End Byte

TXD0 Output: **None**

11. QUALITY AND RELIABILITY

Test Item	Test Conditions	Note
High Temperature Operation	60±3°C , t=240 hrs	
Low Temperature Operation	-5±3°C , t=240 hrs	
High Temperature Storage	70±3°C , t=240 hrs	1,2
Low Temperature Storage	-30±3°C , t=240 hrs	1,2
Thermal Shock Test	-20°C ~ 25°C ~ 70°C 30 min. 5 min. 30 min. (1 cycle) Total 5 cycle	1,2
Storage Humidity Test	60 °C, Humidity 90%, 240 hrs	1,2
Vibration Test (Packing)	Sweep frequency : 10 ~ 55 ~ 10 Hz/1min Amplitude : 0.75mm Test direction : X.Y.Z/3 axis Duration : 30min/each axis	2

Note 1 : Condensation of water is not permitted on the module.

Note 2 : The module should be inspected after 1 hour storage in normal conditions
(15-35°C , 45-65%RH).

Definitions of life end point :

- Current drain should be smaller than the specific value.
- Function of the module should be maintained.
- Appearance and display quality should not have degraded noticeably.
- Contrast ratio should be greater than 50% of the initial value.

12. USE PRECAUTIONS

12.1 Handling precautions

- 1) The polarizing plate may break easily so be careful when handling it. Do not touch, press or rub it with a hard-material tool like tweezers.
- 2) Do not touch the polarizing plate surface with bare hands so as not to make it dirty. If the surface or other related part of the polarizing plate is dirty, soak a soft cotton cloth or chamois leather in benzene and wipe off with it. Do not use chemical liquids such as acetone, toluene and isopropyl alcohol. Failure to do so may bring chemical reaction phenomena and deteriorations.
- 3) Remove any spit or water immediately. If it is left for hours, the suffered part may deform or decolorize.
- 4) If the LCD element breaks and any LC stuff leaks, do not suck or lick it. Also if LC stuff is stuck on your skin or clothing, wash thoroughly with soap and water immediately.

12.2 Installing precautions

- 1) The PCB has many ICs that may be damaged easily by static electricity. To prevent breaking by static electricity from the human body and clothing, earth the human body properly using the high resistance and discharge static electricity during the operation. In this case, however, the resistance value should be approx. $1M\Omega$ and the resistance should be placed near the human body rather than the ground surface. When the indoor space is dry, static electricity may occur easily so be careful. We recommend the indoor space should be kept with humidity of 60% or more. When a soldering iron or other similar tool is used for assembly, be sure to earth it.
- 2) When installing the module and ICs, do not bend or twist them. Failure to do so may crack LC element and cause circuit failure.
- 3) To protect LC element, especially polarizing plate, use a transparent protective plate (e.g., acrylic plate, glass etc) for the product case.
- 4) Do not use an adhesive like a both-side adhesive tape to make LCD surface (polarizing plate) and product case stick together. Failure to do so may cause the polarizing plate to peel off.

12.3 Storage precautions

- 1) Avoid a high temperature and humidity area. Keep the temperature between 0°C and 35°C and also the humidity under 60%.
- 2) Choose the dark spaces where the product is not exposed to direct sunlight or fluorescent light.
- 3) Store the products as they are put in the boxes provided from us or in the same conditions as we recommend.

12.4 Operating precautions

- 1) Do not boost the applied drive voltage abnormally. Failure to do so may break ICs. When applying power voltage, check the electrical features beforehand and be careful. Always turn off the power to the LC module controller before removing or inserting the LC module input connector. If the input connector is removed or inserted while the power is turned on, the LC module internal circuit may break.
- 2) The display response may be late if the operating temperature is under the normal standard, and the display may be out of order if it is above the normal standard. But this is not a failure; this will be restored if it is within the normal standard.
- 3) The LCD contrast varies depending on the visual angle, ambient temperature, power voltage etc. Obtain the optimum contrast by adjusting the LC drive voltage.
- 4) When carrying out the test, do not take the module out of the low-temperature space suddenly. Failure to do so will cause the module condensing, leading to malfunctions.

- 5) Make certain that each signal noise level is within the standard (L level: $0.2V_{dd}$ or less and H level: $0.8V_{dd}$ or more) even if the module has functioned properly. If it is beyond the standard, the module may often malfunction. In addition, always connect the module when making noise level measurements.
- 6) The CMOS ICs are incorporated in the module and the pull-up and pull-down function is not adopted for the input so avoid putting the input signal open while the power is ON.
- 7) The characteristic of the semiconductor element changes when it is exposed to light emissions, therefore ICs on the LCD may malfunction if they receive light emissions. To prevent these malfunctions, design and assemble ICs so that they are shielded from light emissions.
- 8) Crosstalk occurs because of characteristics of the LCD. In general, crosstalk occurs when the regularized display is maintained. Also, crosstalk is affected by the LC drive voltage. Design the contents of the display, considering crosstalk.

12.5 Other

- 1) Do not disassemble or take the LC module into pieces. The LC modules once disassembled or taken into pieces are not the guarantee articles.
- 2) The residual image may exist if the same display pattern is shown for hours. This residual image, however, disappears when another display pattern is shown or the drive is interrupted and left for a while. But this is not a problem on reliability.

13. OUTLINE DIMENSION

1	VIN
2	VIN
3	/BUSY
4	TXD
5	RXD
6	RXD
7	GND
8	GND

Note:

1. Unless indicated, Tolerance "±0.3"
2. UV Glue For OLB Protection.
3. LCD 800x600 (R,G,B) TFT LCD =>CMO 10.4" TFT LCD
4. CN1: STM MSB24013P20HA (HIROSE DF19K-20P-1H) or Equivalent, Mating Connector: STM P24013P20 or Equivalent

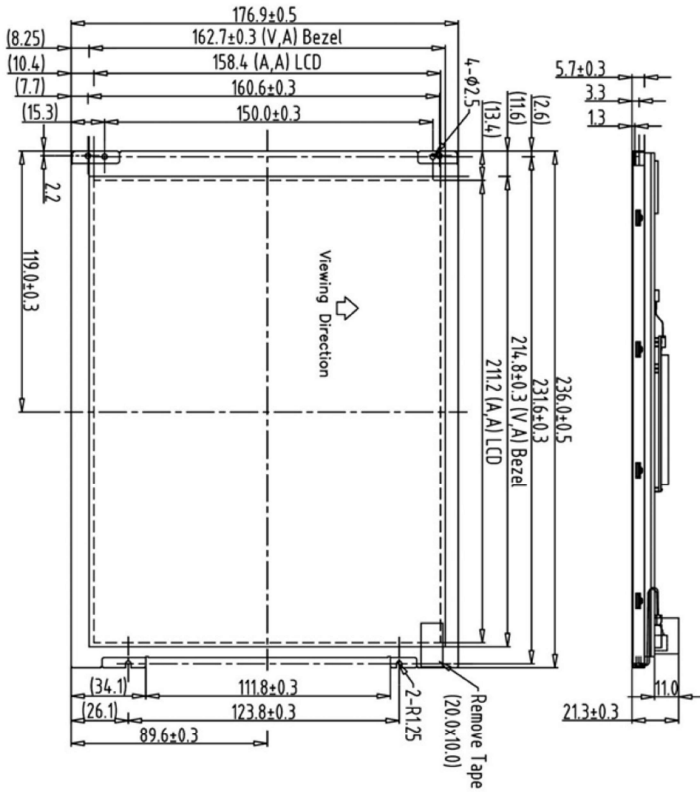
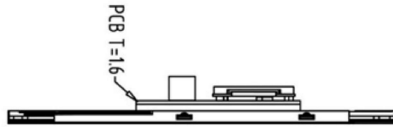
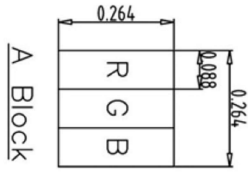

DMN , Akash S.	DATE 11-25-13	 HIGHNESS™
CHK. Rajesh	DATE	
APPD. Amar S.	DATE	TITLE HM104SV111AM-UR (10.4" LVDS UKRT K600)
		DMG. NO.
		SHEET 1 of 1

